

## CARACTERÍSTICAS | CHARACTERISTICS

Móvel de casa de banho em aglomerado.

Interior das gavetas revestido e decorado.

*Chipboard bathroom cabinet.*

*Interior of drawers coated and decorated.*

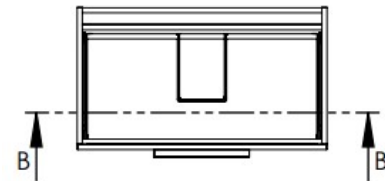
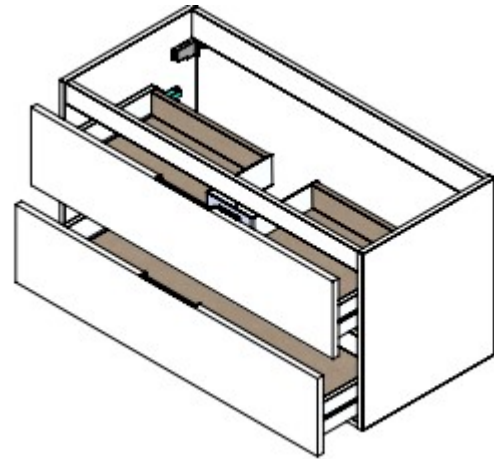

Vista de cima

**DIMENSÕES | DIMENSIONS** 590mm (L) x 453mm (P) x 500mm (A)

**ACABAMENTO | FINISH** Carvalho Mate | *Matt Wood*